

Xibita

SOLO[®]

ROLL-UP BANNER STAND

SET-UP GUIDE

STEP 1: GETTING STARTED

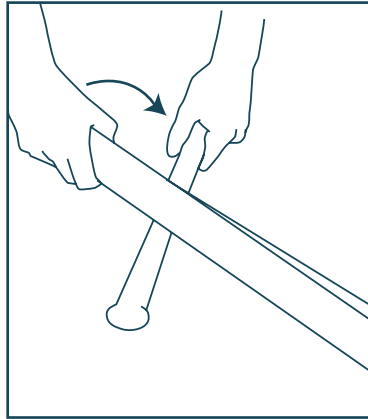

Open and turn the foot 90°

STEP 2: BASE

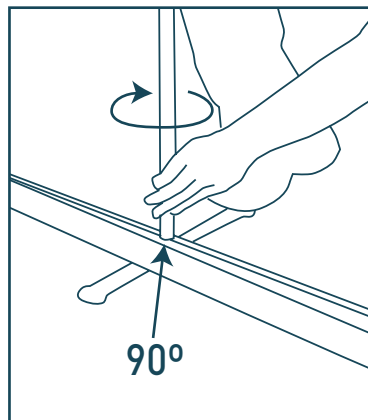

Screw pole in base

STEP 3: POLE

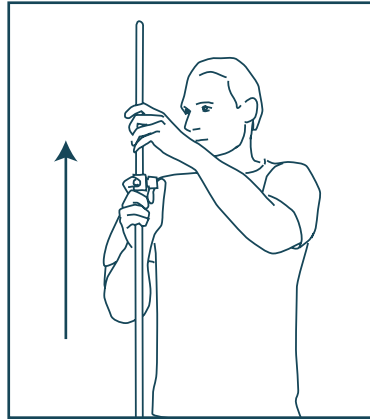

Extend lower pole and fasten the lock

STEP 4: BANNER

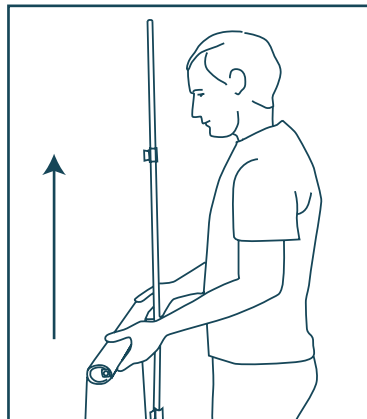

Unroll the banner to the fully extended length

STEP 5: TOP BAR

Insert the pole into the hole in the top bar

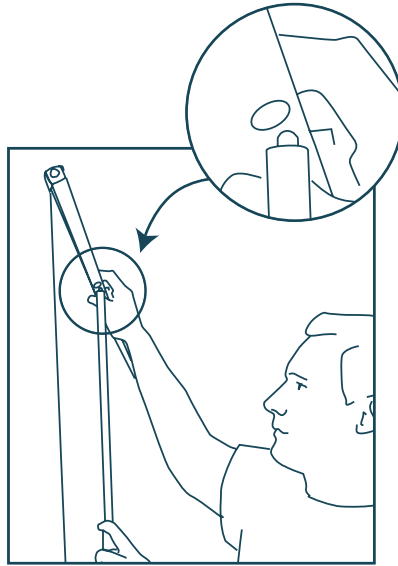

STEP 6: UPPER POLE

Fully extend upper pole and fasten lock

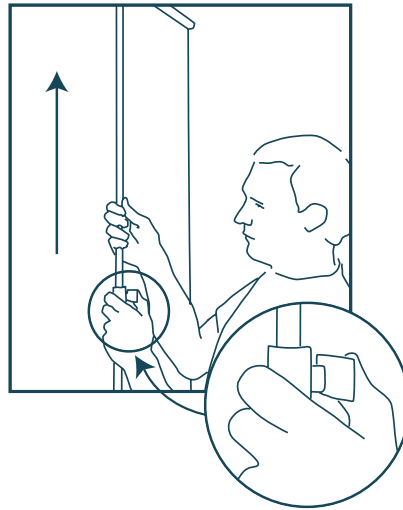

GRAPHIC REPLACEMENT - STEP 1

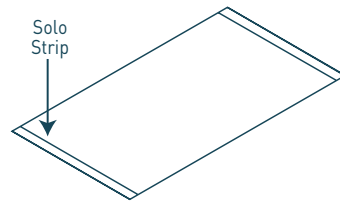

Unroll your new Solo Banner so the Solo Strips are facing up.

STEP 2: TOP BAR

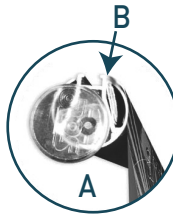

Swing open one end cap on the top bar (A) and slide the top edge of the old banner out (B).

STEP 3: TOP BAR



With the graphic facing out, slide in the top edge of the new banner into the top bar (A). Close the cap (B).



STEP 4: BASE BAR

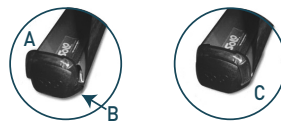

Lastly, swing open one end cap (A) on the base bar and slide the bottom edge of the new banner in with the graphic facing out (B). Close the cap (C).

Xibita

ideas@xibita.com | 1 800 663 1737

xibita.com

Beyond Ordinary